

ITEM NO.	PART NUMBER	DESCRIPTION	QTY.
1	121.88.01.37	Tile-Over Tray 900x1700 Rear Outlet	1

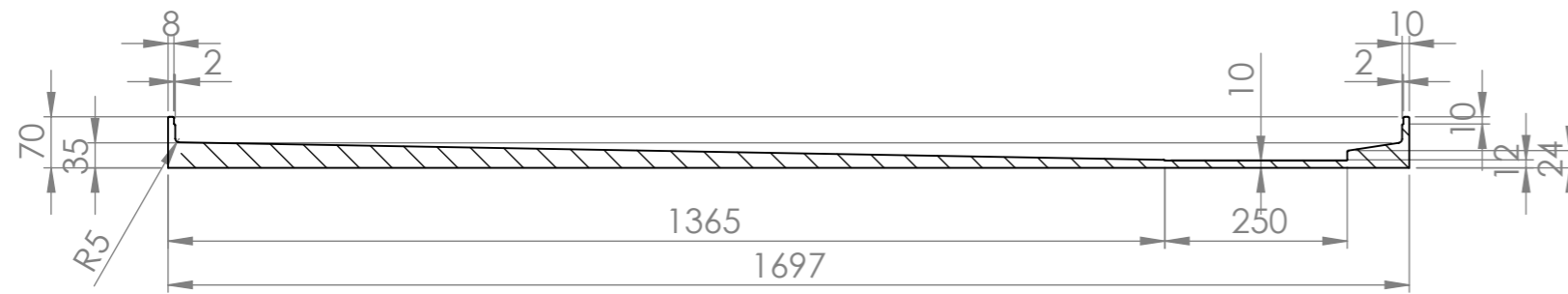

SECTION A-A
CROSS SECTION VIEW

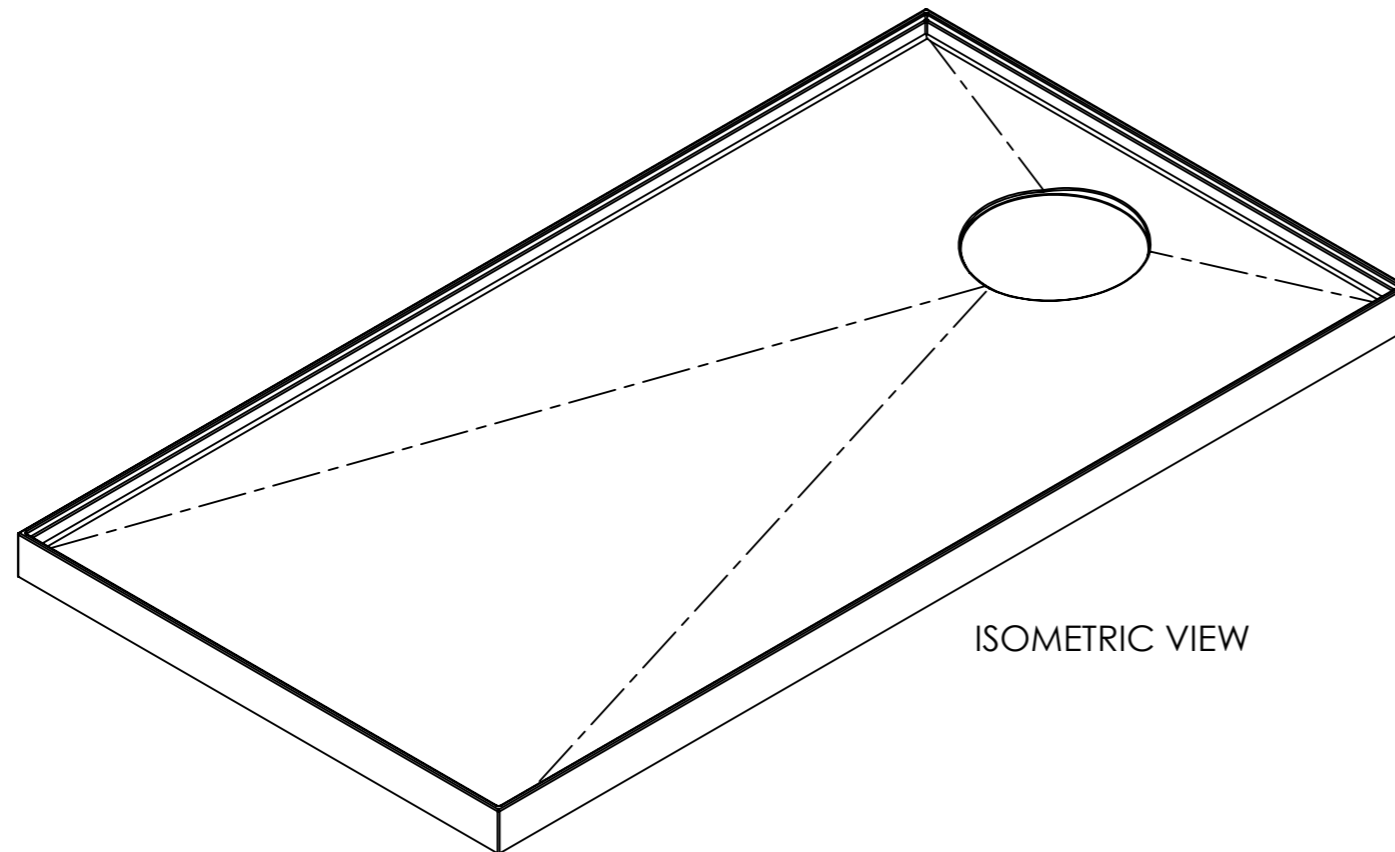

ISOMETRIC VIEW

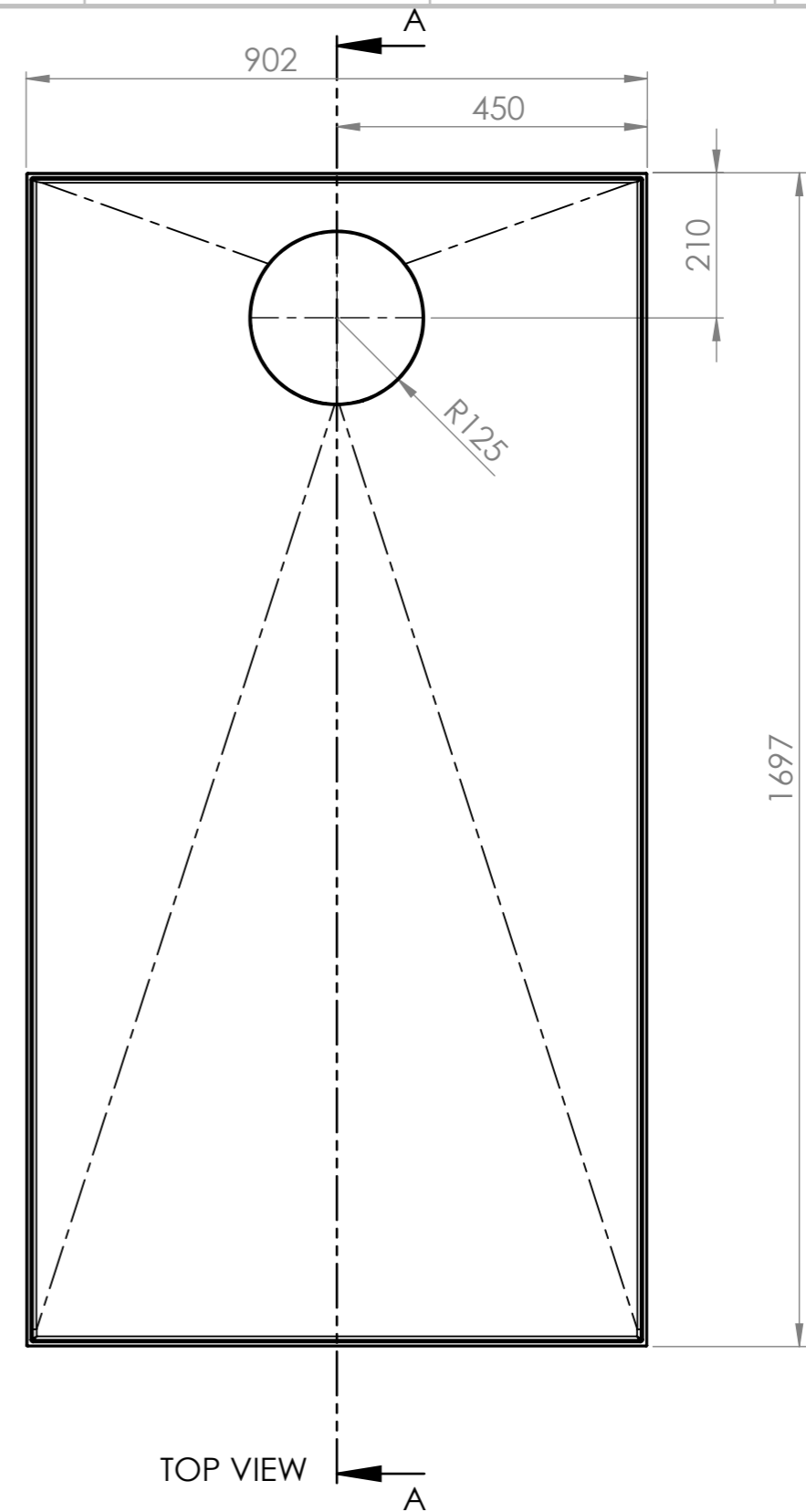

TOP VIEW

 Showerline 5 Kim Court North Geelong VIC 3215 Phone: 1800 688 745 Fax: n/a Email: n/a Website: www.showerline.com.au	Material:	DO NOT SCALE DRAWING		REVISION 1.0
	High Density Polyurethane	TITLE:		
	Part Number:	Tile-Over Tray 900x1700		
	121.88.01.37	Rear Outlet (4Sided)		
UNLESS OTHERWISE SPECIFIED: DIMENSIONS ARE IN MILLIMETERS SURFACE FINISH: TOLERANCES: 5mm ALL FILLETS 2mm UNLESS SPECIFIED	DRAWING rev1.0		SIZE A	DWG NO. 6 of 12
Draw and prepared by	SCALE:1:10		A3	PAGE: 1
NAME SIGNATURE DATE	This drawing and design belongs to Showerline			
Jason Duong	Patent (prov.) 2012904805			

